

The Bullard 88VX Series airline respirators, when properly used, provide a continuous flow of air from a remote air source to the respirator wearer. 88VX Series respirators offer protection from airborne contaminants that are not immediately dangerous to life or health (IDLH), or that do not exceed concentrations allowed by applicable OSHA, EPA, NIOSH, ACGIH, or other regulatory standards and recommendations.

88VX Series airline respirators are approved by NIOSH (TC-19C-293 Type C and CE) to provide respiratory protection in general purpose applications including heavy- and light-duty abrasive blasting, and Type C and CE painting applications. The protective helmet meets ANSI Standard Z89.1-1997 Type 1 Class C requirements for protective headwear for industrial workers. The cape is designed to protect the worker's body from abrasive rebound.

88VX Series respirators are compatible with breathing air sources such as breathing air compressors or Bullard Free-Air® Pumps. Bullard offers the appropriate approved breathing tube assembly and air supply hose to connect the 88VX Series respirator to these breathing air sources.

88VX Series respirators are approved by NIOSH for use with optional climate control devices offered by Bullard.



Table of Contents

Approval Label	2,3	Helmet	12
Component Concept	4	Using Climate Control Devices	12
Warnings	5, 6	Respirator Use	
Cautions/Limitations	7	Donning	13
Operations		Doffing	13
Protection	7	Inspection, Cleaning, and Storage	
Breathing Air Requirements	7, 8	Cape	14
Breathing Air Pressure	9	Headband and Chin Strap	14
Breathing Air Pressure Table	9	Helmet	14
Typical Breathing Air Source and Respirator		Lenses and Window Frame Gasket	14
Configurations	10	Breathing Tube Assembly	15
Respirator Assembly		Air Supply Hoses	15
Sizing the Headband	11	Storage	15
Installing Headband into Inner Shell	12	Parts and Accessories for 88VX Series Airline Respirators	16-18
Attaching Cape to Helmet	12	Return Authorizations	19
Installing Breathing Tube Assembly into Respirator			

▲ WARNING

Read all instructions and warnings before using this respirator. Save this manual for future reference. Failure to follow these instructions could result in death or serious injury.

88VX Series Airline Respirator User Manual



	ALTERNATE AIR HOSE	ACCESSORIES	CAUTIONS AND LIMITATIONS*
X	DC5043		
X	DC5044		
X	DC5047		
X	DC5048		
X	FRIG2000		
X	FRIG2000B		
X	FRIG2000S		
X	54513		
X	54512		
X	54511		
X	54510		
X	5454		
X	5458		
X	5457GOV		
X	5457LOMAC		
X	5457		
X	5454GOV		
X	5454LOMAC		
X	46915LOMAC		
X	46919		
X	46918		
X	4696FM		
X	46928FF		
X	46917FM		
X	46917FF		
X	46917		
X	46916FF		
X	46916FS		
X	46915		
X	46913		
X	4696		
X	4695		
X	V2050S1SHUTOFF		
X	V2025S1SHUTOFF		
X	V2025S1		
X	V2010S1		
X	V2050S1		
X	V2010S1		
X	V20100S1SHUTOFF		
X	V20100S1		
X	V55033GRN		
X	V55033FS		
X	V52533FF		
X	V52533FS		
X	V52533		
X	V55030GRN		
X	V55031		
X	V55030		
X	V55033		
X	V55032		
X	V2531		
X	V52530		
X	V52530GREEN		
X	V52532		
X	V55033FF		
X	DC700ML		
X	DC70LXL		
X	HS		
X	B461B		
X	P771B		
X	P771040		
X	P771020		
X	B461040		
X	P771R		
X	B771R020		
X	P771D015		
X	88VXLC		
X	7714		
			BCDEJMNO

Component Concept

The Bullard 88VX Series airline respirators consist of three components (Figure 1): respirator helmet assembly, breathing tube assembly, and air supply hose. All components must be present and properly assembled to constitute a complete NIOSH approved respirator.

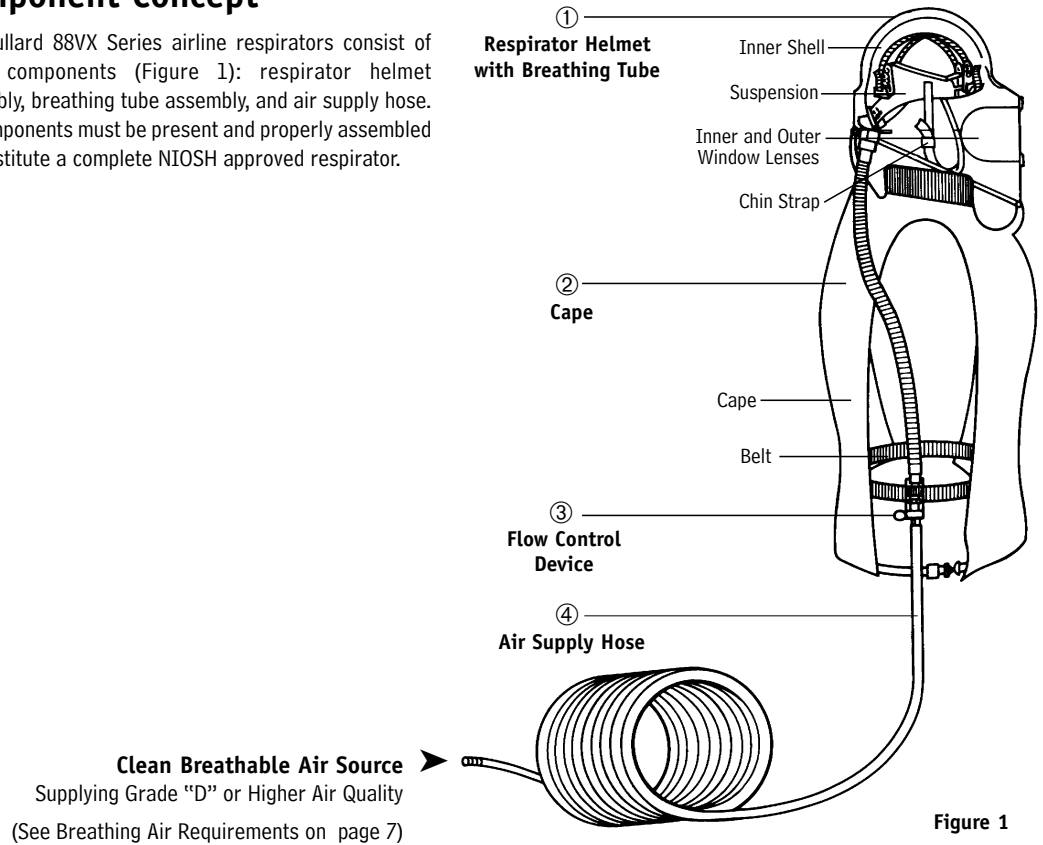

Figure 1

⚠ WARNING

Failure to use complete NIOSH approved Bullard components and replacement parts voids approval of entire assembly. Basic parts are listed on the NIOSH Approval Label on page 3. Failure to follow these instructions could result in death or serious injury.

WARNING

1. This respirator, when properly fitted and used, in conjunction with adherence to OSHA regulations and industry standards, will provide a reasonable degree of protection to the wearer. The respirator significantly reduces, but may not totally eliminate, the breathing of contaminants depending on the work practices involved. Where concentrations of contaminants are excessive, respirator wearers may obtain a higher level of protection from a valve-operated, pressure demand airline respirator or a pressure demand, self contained breathing apparatus (SCBA) respirator. At this time there are no side by side field studies for comparison. However, OSHA does assign higher protection factors to these groups of respirators. Ideally, the employer should measure concentrations inside the breathing zone on a periodic basis to ensure that the wearer is receiving adequate protection.
2. Before using this respirator, Federal Law requires that the employer shall identify and evaluate the respiratory hazard(s) in the workplace, and that this evaluation shall include a reasonable estimate of employee exposures to respiratory hazard(s) and an identification of the contaminant's chemical state and physical form. Do not exceed maximum use concentrations established by OSHA, EPA, NIOSH, ACGIH, or other regulatory standards.
3. Improper respirator use may damage your health and/or cause your death. Improper use may also cause certain life threatening delayed lung diseases such as silicosis, pneumoconiosis, or asbestosis.
4. DO NOT wear this respirator if any of the following conditions exist:
 - Atmosphere is immediately dangerous to your life or health (IDLH),
 - You CANNOT escape without the aid of the respirator,
 - Atmosphere contains less than 19.5% oxygen,
 - Work area is poorly ventilated,
 - Unknown contaminants are present, or
 - Contaminant concentrations are in excess of regulations or recommendations (as described in item 2 above).
5. DO NOT wear this respirator until you have passed a complete medical evaluation (perhaps including a lung x-ray) conducted by qualified medical personnel, and have been trained in the respirator's use, maintenance, and limitations by a qualified individual (appointed by your employer) who has extensive knowledge of Bullard 88VX Series respirators.
6. DO NOT modify or alter this respirator in any manner. Use only NIOSH approved 88VX Series components and replacement parts manufactured by Bullard for use with this respirator.

Failure to use NIOSH-approved Bullard components and replacement parts such as lenses, hoses, flow control devices, capes, and climate control devices, voids NIOSH approval of the entire respirator, invalidates all Bullard warranties, and could cause death, serious injury, lung disease, or exposure to other hazardous or life threatening conditions.
7. Inspect all components of this respirator system daily for signs of wear, tear, or damage that might reduce the degree of protection originally provided.

Immediately replace worn or damaged components with NIOSH approved Bullard 88VX Series components or remove the respirator from service. (See INSPECTION, CLEANING, AND STORAGE section on pages 14-15 for proper maintenance of 88VX Series respirators.)
8. Be certain your employer has determined that the breathing air source provides at least Grade D breathable air. This respirator must be supplied with clean breathable air at all times.
9. Do not connect the respirator's air supply hose to nitrogen, oxygen, toxic gases, inert gases, or other unbreathable, non-Grade D air sources. To prevent this, the employer shall use airline couplings used for this respirator that shall be incompatible with outlets for other gas systems, as required by OSHA regulation 29 CFR 1910.134 (i) (8). Check the air source before using the respirator. Failure to connect to the proper air source could result in death or serious injury.
10. Do not use this respirator in poorly ventilated areas or confined spaces such as tanks, small rooms, tunnels, or vessels unless the confined space is well ventilated and the contaminant concentrations are below the upper limit recommended for this respirator. In addition, follow all procedures for confined space entry, operation and exit as defined in applicable regulations and standards, including 29 CFR 1910.146.

(Continued on Page 6)

(Continued from Page 5)

▲ WARNING

11. If you have any questions concerning the use of this respirator, or if you are not sure whether the atmosphere you are working in is immediately dangerous to life or health (IDLH), ask your employer. All instructions for the use and care of this product must be supplied to you by your employer as recommended by the manufacturer and as required by Federal Law (29 CFR 1910.134).
12. Do not use this respirator for underwater diving.
13. Leave work area immediately if:
 - Any respirator component becomes damaged.
 - Airflow into respirator stops or slows down.
 - Air pressure gauge drops below the minimum specified in the Breathing Air Pressure Table in the 88VX Series User Manual.
 - Breathing becomes difficult.
 - You become dizzy, nauseous, too hot, too cold, or ill.
 - You taste, smell, or see contaminants inside the respirator hood.
 - Your vision becomes impaired.
14. Historically, the incidence of disease from overexposure to toxic substances almost always occurs because the OSHA regulations and industry standards applicable to the work practices involved are not followed. It is, therefore, imperative that the employer acquaint itself with and follow all of these standards and regulations. **REMEMBER:**
 - Respiratory protection is but one component of safe work practices. To minimize the chances of overexposure, all safety regulations and standards must be followed; and
 - Respiratory protection is the last line of defense to be employed. The employer must first eliminate or minimize the levels of toxic substances in the work place by accepted engineering control measures. Assuming the employer and the wearer do their part, this respirator should provide the wearer with an adequate degree of protection.

88VX Series Airline Respirator User Manual

Cautions and Limitations

- B. Not for use in atmospheres immediately dangerous to life or health.
- C. Do not exceed maximum use concentrations established by regulatory standards.
- D. Airline respirators can be used only when respirators are supplied with respirable air meeting the requirements of CGA G-7.1 Grade D or higher quality.
- E. Use only the pressure ranges and hose lengths specified in the instruction manual.
- J. Failure to properly use and maintain this product could result in death or serious injury.
- M. All approved respirators shall be selected, fitted, used, and maintained in accordance with MSHA, OSHA, and other applicable regulations.
- N. Never substitute, modify, add, or omit parts. Use only exact replacement parts in the configuration as specified by the manufacturer.
- O. Refer to users instructions, and/or maintenance manuals for information on use and maintenance of these respirators.

For technical assistance call or write:

Bullard
1898 Safety Way
Cynthiana, KY 41031-9303
Toll free: 877-BULLARD (285-5273)
Phone: 859-234-6616
Fax: 859-234-6858

Operations

Protection

Respiratory

This respirator is NIOSH approved (TC-19C-293) as a Type C and CE respirator. It can be worn for general purpose applications, including heavy and light-duty abrasive blasting, and spray painting.

This respirator is not approved for use in any atmosphere immediately dangerous to life or health (IDLH), or from which the wearer cannot escape without the aid of the respirator.

Head

88VX Series respirators meet ANSI Standard Z89.1-1997 Type I Class C requirements for protective headwear for industrial workers. The helmet is designed to provide limited head protection by reducing the force of falling objects striking the top of the helmet.

Face

The respirator's inner window meets ANSI Z87.1-1989 requirements for face protection. It provides limited face protection from flying particles or spray of hazardous liquids, but is not shatterproof.

Eyes

88VX Series respirators DO NOT provide eye protection. Wear approved safety glasses or goggles at all times.

Ears

88VX Series respirators DO NOT provide hearing protection. Use properly fitted earmuffs, earplugs or other protection when exposed to high noise levels.

Breathing Air Requirements

Air Quality

Respirable, breathing air must be supplied to the point-of-attachment of the approved Bullard air supply hose. The point-of-attachment is the point at which the air supply hose connects to the air source. A pressure gauge attached to the air source is used to monitor the pressure of air provided to the respirator wearer (Figure 2, and Figure 3, Page 10).

WARNING

This respirator MUST be supplied with clean, breathable air, Grade D or better, at all times. This respirator does NOT purify air or filter out contaminants. Failure to follow these instructions could result in death or serious injury.

Supplied breathing air must AT LEAST meet the requirements for Type 1 gaseous air as described in the Compressed Gas Association Commodity Specification G-7.1 (Grade D or higher quality), and as specified by Federal Law 42 CFR, Part 84, Subpart J, 84.141(b) and 29 CFR 1910.134(i).

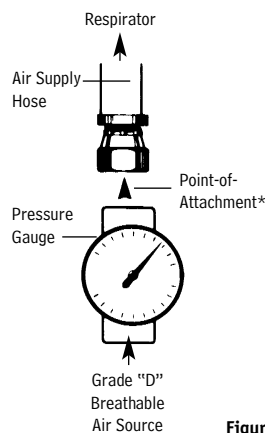

Figure 2

*Use either a V13 hose-to-hose pipe adapter or a quick-disconnect coupler to attach the air supply hose.

The requirements for Grade D breathable air include:

Oxygen	19.5-23.5%
Hydrocarbons (condensed) in mg/m3	5 mg/m3 max.
Carbon monoxide	10 ppm max.
Carbon dioxide	1,000 ppm max.
Odor	Lack of noticeable odor
No toxic contaminants at levels that make air unsafe to breathe.	

Contact the Compressed Gas Association (1725 Jefferson Davis Hwy, Arlington, VA 22202) for complete details on Commodity Specification G-7.1.

Air Source

Locate the source of supplied air whether it is an air compressor or an ambient air pump, such as a Bullard Free-Air pump, in a clean air environment. Locate the air source far enough from your work site to ensure the air remains contaminant-free. Always use an inlet filter on your air source.

Use suitable after-cooler/dryers, filters, carbon monoxide monitors and alarms, like the Bullard CAC01 Alert-1™ CO monitor, as necessary to assure clean, breathable air at all times.

The air should be regularly sampled to be sure that it meets Grade D requirements.

Breathing Air Pressure

Air pressure must be continually monitored at the point-of-attachment while operating this respirator. A reliable air pressure gauge must be present to permit you to continually monitor the pressure during actual respirator operation.

⚠ WARNING

Failure to supply the minimum required pressure at the point-of-attachment for your hose length and type will reduce airflow and could result in death or serious injury.

The Breathing Air Pressure Table (page 9) defines the air pressure ranges necessary to provide 88VX Series respirators with a volume of air that falls within the required range of 6-15 cfm or 170-425 lpm (Ref. 42 CFR, Part 84, Subpart J, Table 8).

Make sure you understand the information in the Breathing Air Pressure Table before using this respirator.

1. Determine the type of air source you are using (column 1), then find your flow control valve/climate control device (column 2).
2. Be sure your Bullard air supply hose(s) (column 3) is approved for use with your flow control valve/climate control device.
3. Determine that your Bullard air supply hose is within the approved length (column 4).
4. Make sure you have not exceeded the maximum number of hose sections (column 5).
5. Set the air pressure at the point-of-attachment within the required pressure range (column 6) for your flow control valve/climate control device, and air supply hose type and length. Accurate pressure readings can only be attained when air is flowing into the respirator.

NIOSH approved Bullard air supply hose(s) MUST be used between the breathing tube connection fitting on the wearer's belt and the point-of-attachment to the air supply (Figure 3, Page 10).

NIOSH approved Bullard quick-disconnect fittings MUST be used to connect V5 or V20 hose lengths together. When connecting lengths of V10 hose, only use Bullard V11 hose-to-hose adapters. Secure connection(s) until wrenchtight and leakfree. Total connected hose length and number of hoses MUST be within the ranges specified on the Breathing Air Pressure Table (Page 9) and the respirator's NIOSH approval label (Page 3).

The breathing tube connection fitting MUST be secured to the belt that is supplied with this respirator. Securing the air entry connection fitting helps prevent the air supply hose from snagging, disconnecting or pulling the respirator helmet off your head.

88VX Series Airline Respirator User Manual

Breathing Air Pressure Table

This table defines the air pressure ranges necessary to provide 88VX Series respirators with a volume of air that falls within the required range of 6-15 cfm or 170-425 lpm according to U.S. Government regulations (42 CFR, Subpart J, 84.150, Table 8).

1	2	3	4	5	6		
Air Source	Flow Control Valve/ Climate Control Device	Air Supply Hose	Air Supply Hose Length (feet)	Maximum Number of Hose Sections	Required Pressure Range (psig air)		
Stationary or Portable Air Compressor	F30, F30B, F30S, F31, F32, F33, F34, F37, F38	V10	25	1	14-15		
			50	2	15-18		
			100	3	19-24		
			150	4	23-29		
			200	5	25-34		
			250-300	5	31-39		
	F40, F40B, F40S, F41, F42, F43, F44, F47, F48	V10	25	1	22-25		
			50	2	24-27		
			100	3	27-32		
			150	4	30-37		
			200	5	33-40		
			250-300	5	38-45		
	AC100030, AC100030B, AC100030S, AC100031, AC100032, AC100033, AC100034, AC100037, ACC100038	V10	25-50	2	55-65		
			75-150	3	60-70		
			175-300	5	65-75		
			V5	25	1	55-65	
				50	1	56-69	
				DC5040, DC5040B, DC5040S, DC5041, DC5042, DC5043, DC5044, DC5047, DC5048	V10	50	2
	100	3	59-63				
	150	3	68-72				
	200	3	80-84				
	250	3	85-92				
	300	5	90-98				
	HC240030, HC240030B, HC240030S, HC240031, HC240032, HC240033, HC240034, HC240037, HC240038	V10	25	1	61-63		
50			2	63-65			
100			3	68-70			
150			4	73-75			
200			4	77-79			
250			5	80-82			
Bullard Free-Air® Pumps	F35, F35B, F35S	V20	50	1	4-6		
			100	2	6-8		
			200	2	10-15		
			300	3	13-18		
			Frigitron 2000 Frigitron 2000B Frigitron 2000S	V20	50	1	16-22
					100	2	18-25
200	2	22-30					
300	3	25-34					

Typical Breathing Air Source and Respirator Configurations

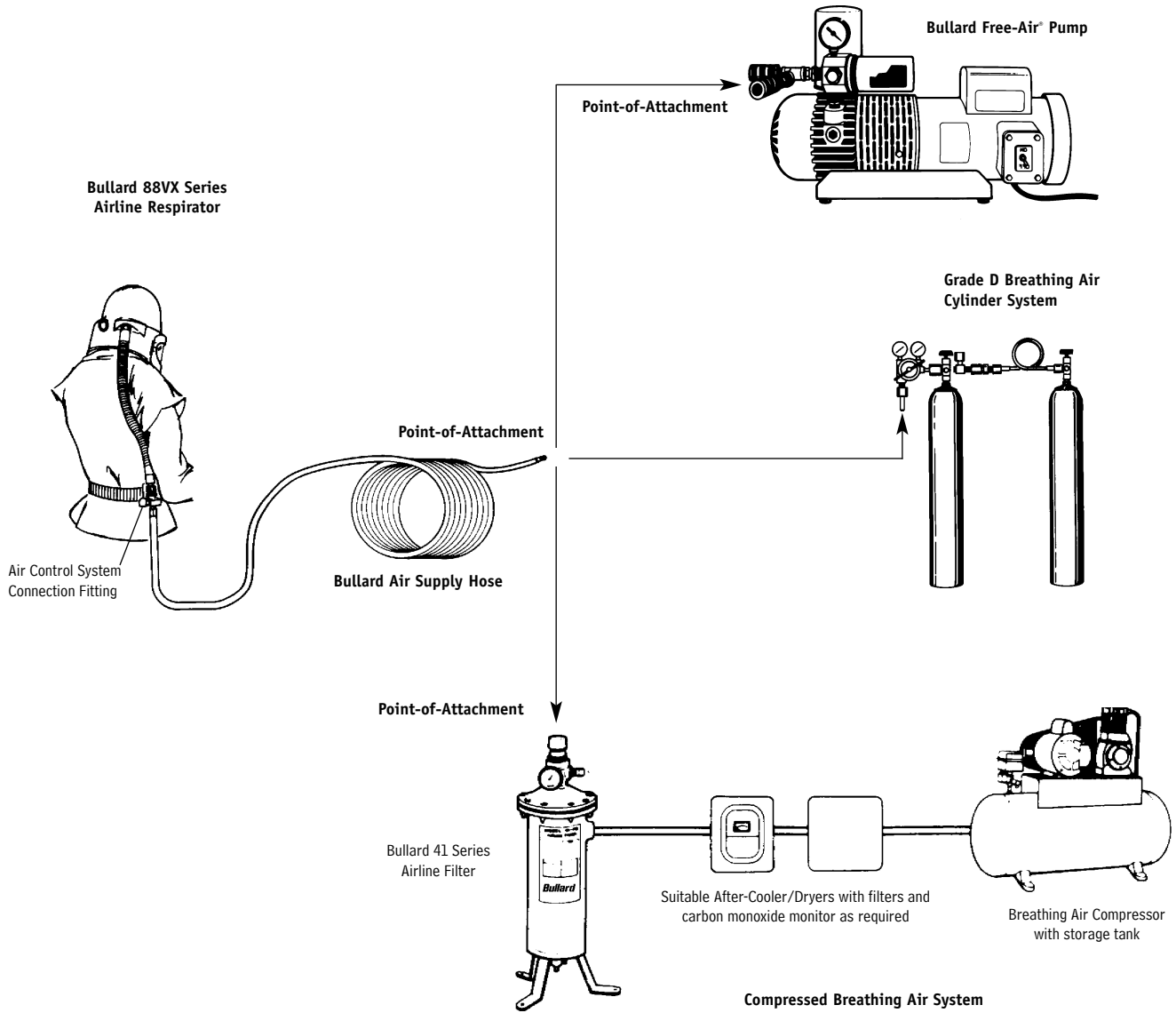

Figure 3

Point-of-Attachment

The point -of-attachment is the point at which the air supply hose connects to the air source. A pressure gauge attached to the air source is used to monitor the pressure of air provided to the respirator wearer.

Respirator Assembly

Before assembling this respirator, read the warning labels on the inside of the respirator cape and the helmet shell and this manual in full.

Remove and read the warning card inserted between the respirator's two lenses.

Sizing the Headband

Before you can size the headband suspension, the cape and headband must be removed from the helmet using the following steps:

1. Open hinged window frame by lifting up on window latch.
2. Remove cape from helmet by lifting up on clamp and disengaging cape from helmet groove (Figure 4).
3. Turn helmet upside down. To remove inner shell from helmet, hook index finger into loop on back of inner shell. Press thumb against helmet rim and pull loop toward front of helmet, then pull up and away from helmet (Figure 5). This releases inner shell.
4. Size the standard 88VXTG headband by squeezing top and bottom edges of rear buckle together with your thumb and forefinger. At the same time, decrease headband size by sliding right hand portion of headband through buckle.
5. Place the headband on your head. Pull down allowing headband to expand until it feels comfortable. Headband automatically adjusts to your size and locks when you release your grip (Figure 6).
6. Remove headband from your head.



NOTE

If using the optional 88VXRT ratchet headband, refer to the instruction sheet provided with the 88VXRT.

Adjusting Suspension for Vertical Fit

The headband may be raised or lowered in the front and/or back by repositioning the hanger keys. Vertical adjustment makes headband ride higher or lower on wearer's head. It also can adjust the tilt forward or backward.

1. Rotate hanger key 90° in either direction until hole in hanger key aligns with post on headband. Pull key away from headband. (Figure 7).
2. Move key to desired vertical position.
3. Rotate hanger key 90° toward headband until key locks in place (Figure 7).
4. Repeat steps 1-3 for other hanger keys.

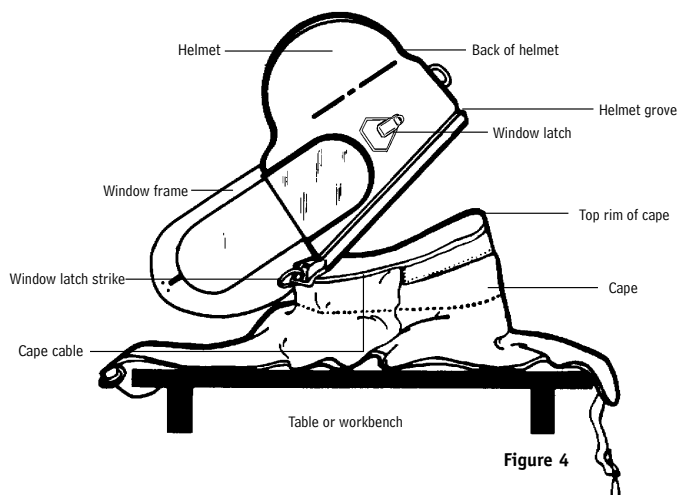

Figure 4

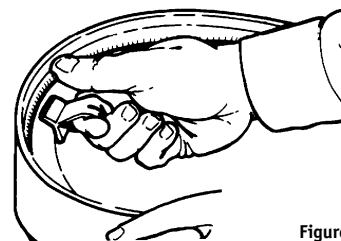

Figure 5

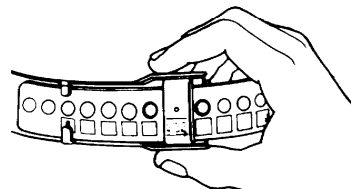

Figure 6

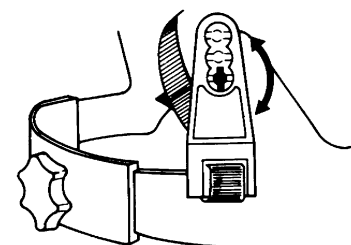

Figure 7

Installing Headband into Inner Shell

1. Turn inner shell and headband suspension upside down.
2. Place headband inside shell with brow pad facing front of shell.
3. Bending hanger keys at hinge, insert keys into respective key slots. Push firmly until keys snap into place (Figure 8).

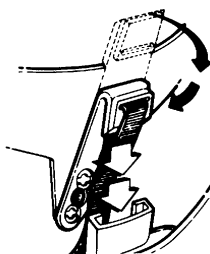

Figure 8

4. Insert inner shell into helmet with front of shell tilted down. Align round hole located at front of shell with washer at inside front of helmet. Press back of shell into helmet until it snaps in place.

Using the 20NC Chin Strap

1. Attach chin strap to inner shell by sliding chin strap keyway slot over plastic head on button inside the inner shell. Refer to 20NC chin strap installation instructions.
2. Put helmet on your head. Adjust chin strap length with the plastic slide.

Optional Lens Covers

1. If desired, apply optional lens covers designed to protect the respirator's plastic lens. Apply 2-3 lens covers at a time.
2. When lens becomes soiled, remove by pulling tab at edge of lens cover to clear your vision.

Attaching Cape to Helmet

1. Place cape on table or workbench. (Figure 4, page 11)
2. With window frame open, place helmet on top of cape.
3. Line up the clamp on the cape with the front center of the helmet (Figure 4, page 11).



NOTE

Installation is easiest when started at the front of cape and helmet.

4. Ease cape rim completely into the groove along helmet edge, working your way to the back. Be certain cape is completely in place at every point along helmet's bottom edge.
5. Snap the clamp to tighten cable and hold cape snugly on helmet, while ensuring the cape stays in the groove.
6. Close and latch window frame.

Installing Breathing Tube Assembly onto Respirator Helmet

1. Connect breathing tube assembly to helmet by screwing plastic hose connector to fitting located on the side of the helmet. Turn clockwise to tighten (Figure 9).

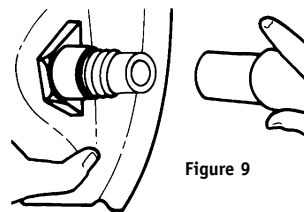

Figure 9



NOTE

Do not remove foam from inside the breathing tube. The foam helps reduce the noise level of the incoming air.

Using Climate Control Devices

88VX Series respirators are approved by NIOSH for use with five optional Bullard climate control devices: AC1000 Series, DC50 Series, HC2400 Series and Frigitron 2000 Series.

1. Follow the instructions supplied with your climate control device.
2. Be sure to use only the 88VXBT with your climate control device.
3. Screw nylon hose connector on end of breathing tube to hose thread on climate control device.
4. Firmly tighten hose connector by hand (Figure 10).
5. Lace belt supplied with respirator through belt loop bracket on climate control device.

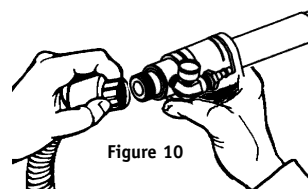

Figure 10

⚠ WARNING

Only use climate control devices manufactured by Bullard. Substituting other climate control devices will void the NIOSH approval and could result in death or serious injury.

88VX Respirator Use

⚠ WARNING

Do not put on or remove this respirator in a hazardous atmosphere. Do not remove this respirator in a hazardous atmosphere except for emergency escape purposes. Failure to follow these instructions could result in death or serious injury.

Donning

Before using your 88VX Series respirator, complete the assembly instructions given on pages 11-12. Before putting on respirator, make sure there is no dirt, dust, or contaminants inside the helmet.

1. Connect the Bullard air supply hose that is part of the NIOSH approved assembly to the air source supplying Grade D breathing air. Turn on the breathing air source.
2. With air flowing, connect breathing tube assembly to air supply hose. Connect quick-disconnect fitting on breathing tube assembly to quick-disconnect coupler on air supply hose. Once fitting is secured, release coupling sleeve to lock fittings together. Pull on both hoses to make sure they are attached securely.
3. Adjust air pressure at point-of-attachment (Figure 2, Page 7) to within the approved pressure range on the Breathing Air Pressure Table (Page 9) for approved pressure ranges.
4. With air still flowing, lower 88VX Series respirator helmet onto your head for a comfortable fit.
5. Position headband for a comfortable fit. See instructions on pages 11 and 12 for proper headband sizing.
6. Pull elastic chin strap under your chin and adjust for a secure and comfortable fit. The chin strap will help balance the helmet and should be worn at all times.
7. Be sure that the knitted inner neck cuff fits snugly around your neck to help provide a barrier to airborne contaminants.
8. With breathing tube assembly attached to the helmet, fasten belt around waist or hips and adjust for comfort.
9. Pull respirator cape around your body and secure sides by connecting the snap hooks. If using the Golden Gate cape, first secure the ties that connect in back, then in front. If using the Hibernia parka, tighten belt at waist.
10. Recheck air pressure and adjust if necessary.
11. With air still flowing into your respirator, you are now ready to enter work area.



NOTE

OSHA respirator regulations do not require fit testing of supplied air hoods and helmets.

Doffing

When finished working, leave work area wearing respirator and with air still flowing. Once outside contaminated area, remove respirator and then disconnect the air supply hose using the quick-disconnect fittings.



NOTE

If using V20 Series (1/2" I.D.) air supply hose, the quick-disconnect coupler does not have a shut-off valve. Therefore, air will continue to flow freely after disconnecting hose from respirator.

⚠ WARNING

Leave work immediately if:

- Any respirator component becomes damaged.
- Airflow into respirator helmet stops or slows down.
- Air pressure gauge drops below the minimum specified in the Breathing Air Pressure Table (page 9).
- Breathing becomes difficult.
- You become dizzy, nauseous, too hot, too cold or ill.
- You taste, smell or see contaminants inside respirator helmet.
- Vision becomes impaired.

Failure to follow these instructions could result in death or serious injury.

⚠ WARNING

Do not leave respirator in work area. Respirable dust contaminants can remain suspended in the air for more than one hour after work activity ceases, even though you may not see them. Proper work practice requires you to wear the respirator until you are outside the contaminated area. Failure to don, doff and store the respirator outside of contaminated area could result in exposure to contaminants. Failure to follow these instructions could result in death or serious injury.



Adjust neck cuff



Always wear respirator in work area

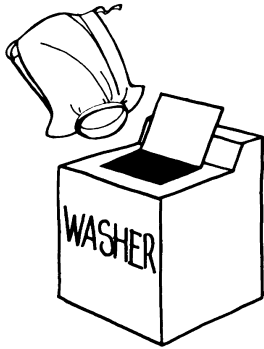

Your respirator cape may be machine washed

Inspection, Cleaning and Storage

Bullard's 88VX Series respirators have a limited service life. Therefore, a regular inspection and replacement program must be conducted. Certain parts such as capes and lenses must be replaced frequently.

The 88VX Series respirator and all component parts and assemblies should be inspected for damage or excessive wear, before and after each use, to ensure proper functioning. Immediately remove the respirator from service and replace parts or assemblies that show any sign of failure or excessive wear that might reduce the degree of protection originally provided.

Use only complete NIOSH approved Bullard 88VX Series components and replacement parts on this respirator. Refer to parts list (Pages 16-17) for correct part numbers.

Since respirator use and the quality of maintenance performed vary with each job site, it is impossible to provide a specific time frame for respirator replacement. As a general guideline, the 88VX Series respirator should be replaced after two years of service or less.

This respirator should be cleaned and sanitized at least weekly, or more often if subjected to heavy use. Respirators used by more than one person must be cleaned, inspected and sanitized after each use. If not cleaned, contamination may cause illness or disease.

REMEMBER, THE AIR YOU BREATHE WILL NOT BE CLEAN UNLESS THE RESPIRATOR YOU WEAR IS CLEAN.

Cape

Inspection

Remove the cape from the respirator helmet and inspect it for rips, tears or damage from excessive wear that might reduce the degree of protection originally provided. Inspect the inner neck cuff for elasticity.

If you detect any of these signs, replace your cape immediately or remove the respirator from service.

⚠ WARNING

Do not substitute any capes other than those manufactured by Bullard. Substituting other capes will void the NIOSH approval and could result in death or serious injury.

Cleaning

Machine wash the cape in cold or warm water using a gentle cycle. Use a mild laundry detergent. Air-dry only. After cleaning, carefully inspect the cape once again for signs of damage.

Do not use volatile solvents to clean this respirator or any parts and assemblies. Strong cleaning and disinfecting agents, and many solvents, can damage the plastic parts.

Headband and Chin Strap

Inspection

Remove the headband suspension and chin strap from the inner shell. Inspect the headband for cracks, frayed or cut crown straps, torn headband or size adjustment slots, loss of pliability or other signs of excessive wear. Check the chin strap for loss of elasticity, cuts and cracked hanger clips.

If damage is detected, replace parts immediately with Bullard replacement parts or remove the respirator from service.

Cleaning

The headband suspension and chin strap should be hand-sponged with warm water and mild detergent, rinsed and air-dried. After cleaning and before reassembling, once again carefully inspect the parts for signs of damage.

Helmet

Inspection

Inspect the helmet and inner shell for nicks, gouges, cracks, holes and any damage due to impact, rough treatment or wear.

If damage is detected, replace parts immediately with Bullard replacement parts or remove the respirator from service.

Cleaning

The helmet, inner shell, and window frame should be hand-sponged with warm water and mild detergent, rinsed and air-dried.

After cleaning and before reassembling, once again carefully inspect the helmet and parts for signs of damage

Lenses and Window Frame Gasket

Inspection

Be sure the plastic inner lens fits securely in the window frame gasket. Remove any grit or dust from the gasket. Be sure the plastic outer lens is installed underneath the clamps on the back of the outer window frame. Inspect the window frame gasket closely for cuts, wear or damage that will prevent a proper seal against the inner faceshield lens or the helmet window frame.

If damage is detected, replace parts immediately with Bullard replacement parts or remove the respirator from service.

Cleaning

To clean the lenses, hand-sponge with warm water and mild detergent, rinse and air-dry.

⚠ WARNING

Do not use lenses other than those listed on the next page. Substituting other lenses voids the NIOSH approval. Use of non-Bullard lenses may allow contaminants to enter the respirator and could result in death or serious injury.

88VX Series Airline Respirator User Manual



NOTE

All Bullard lenses are stamped with the appropriate Bullard part number described below.

Bullard Lens Description	Part No.
Inner lens for 88VX Series Respirators (oval)	771B
Outer lenses for 88VX Series Respirators (oval)	771
Inner lens for 88VX Series Respirators (rectangular)	461B
Outer lenses for 88VX Series Respirators (rectangular)	461, 461R, 771R

Breathing Tube Assembly

Inspection

Inspect the breathing tube for tears, cracks, holes, or excessive wear that might reduce the degree of protection originally provided. If any signs of excessive wear are present, replace the breathing tube immediately or remove the respirator from service.

Cleaning

To clean the breathing tube, hand-sponge with warm water and mild detergent, being careful not to get water inside. Rinse and air-dry. After cleaning, once again carefully inspect breathing tube for signs of damage.

CAUTION

Do not cut or remove foam that is inside the breathing tube. The foam helps reduce the noise level of the incoming air supply. It does not filter or purify your breathing air. NIOSH has approved this respirator with the foam in place. Failure to observe these instructions may result in minor or moderate injury.

Air Supply Hose

Inspection

The starter and extension hose(s) should be inspected closely for abrasions, corrosion, cuts, cracks and blistering. Be sure the hose fittings are crimped tightly to the hose so that air cannot escape. Make sure the hose has not been kinked or crushed by any equipment that may have rolled over it.

If any of the above signs are present or any other signs of excessive wear are detected, replace the air supply hose(s) immediately or remove the respirator from service.

Cleaning

The air supply hose(s) should be hand-sponged with warm water and mild detergent, rinsed and air-dried. Do not get water inside the air supply hose. After cleaning, once again carefully inspect air supply hose(s) for signs of damage.

WARNING

Only use hoses that are NIOSH approved for use with this respirator. Other hoses could reduce airflow and protection, and expose the wearer to life threatening conditions. Failure to follow these instructions could result in death or serious injury.

Storage

After reusable respirator components have been cleaned, dried and inspected, place them in a plastic bag or an airtight container.

Store the respirator and parts where they will be protected from contamination, distortion and damage from elements such as dust, direct sunlight, heat, extreme cold, excessive moisture and harmful chemicals.



Store in a clean place away from contaminants

Parts and Accessories for 88VX Series Airline Respirators

88VX Series supplied-air respirators consist of four components: 1.) respirator helmet assembly with breathing tube, 2.) cape, 3.) flow control device, and 4.) air supply hose. There are options for some components to fit customer specifications. All components must be present and properly assembled, including a Bullard air supply hose, to constitute a complete NIOSH approved respirator (Approval No. TC-19C-293, Type C and CE).

CATALOG NUMBER	DESCRIPTION	CATALOG NUMBER	DESCRIPTION
Parts for 88VX Series Respirators			
88VXTG	4-point headband suspension with sizing posts and Sportek® brow pad (25/pkg)		
88VXRT	4-point headband suspension with Sure-Lock ratchet sizing knob and Sportek brow pad (25/pkg)		
20NC	Elastic Chin Strap		
99PL	Inner shell/air plenum		
88CK	Breathing tube connector kit		
88VXAK	Oval door/Gasket/Latch Kit Assembly		
88VXRAK	Rectangular door/Gasket/Latch Kit Assembly		
BFW	Box Front Adapter Kit, complete (for 88 and 88VX Series only)		
77GLT	Tempered Glass Lens for BFW		
77LG	Box Front Lens Gasket		
G4613	88VXR Window Frame Gasket (rectangular)		
G7713	88VXR Window Frame Gasket (oval)		
88VXUGK	88VX Upgrade Kit: Includes 88VXAK, 99PL, 88VXTG, 46VX and 88VXBT		
Lenses and Mylar Covers			
Lenses for 88VX Series (oval)			
771B	Inner Plastic Lens, .040" thick (25/pkg)		
771(.040)	Outer Plastic Lens, .040" thick (25/pkg)		
771(.020)	Outer Plastic Lens, .020" thick (50/pkg)		
Lenses for 88VX Series (rectangular)			
461B	Inner Plastic Lens, .040" thick (25/pkg)		
461	Outer Plastic Lens, .040" thick (25/pkg)		
461R	Outer Plastic Lens, .015" thick (50/pkg)		
771R(.015)	Outer Plastic Lens, .015" thick (50/pkg)		
7714	Clear Mylar Lens Cover, Adhesive-Backed (25/pkg)		
88VXLC	Clear Mylar Lens Cover, Perforated-Edges with pull tab (25/pkg)		
Capes			
46VX	Tan Nylon Cape - 28" length		
13VX	Tan Nylon Cape - 38" length		
21VX	"Golden Gate" style - Tan Nylon Cape - 38" length		
36VX	Hibernia Parka - Tan Nylon Parka with sleeves - 38" length		
36XLVX	Hibernia Parka - Tan Nylon Parka with sleeves - 38" length, extra-large		
Flow Control Devices (Includes Belt)			
Adjustable Flow			
EVX40	Breathing tube assembly - 1/4" Industrial Interchange (steel) quick-disconnect fitting		
AC100030	Air Conditioner - 1/4" Industrial Interchange (steel) quick-disconnect fitting		
Frigitron 2000	Air Conditioner - 1/2" Industrial Interchange (steel) quick-disconnect fitting, (for use with Bullard EDP30 Free-Air pump)		
HC240030	Hot/Cold tube - 1/4" Industrial Interchange (steel) quick-disconnect fitting		
DC5040	DUAL-COOL tube - 1/4" Industrial Interchange (steel) quick disconnect fitting. Order DUAL-COOL vest separately		
Constant Flow			
EVX30	Breathing tube assembly - 1/4" Industrial Interchange (steel) quick-disconnect fitting		
EVX35	Breathing tube assembly - 1/2" Industrial Interchange (steel) quick-disconnect fitting		
Dual-Cool Vest			
DC70ML	DUAL-COOL vest. Size: M/L. Order DUAL-COOL tube separately.		
DC70LXXL	DUAL-COOL vest. Size: XL/XXL. Order DUAL-COOL tube separately.		
CH60	Connector hose for use with DUAL-COOL		
Replacement Parts for Breathing Tube Assemblies			
88VXBT	Breathing tube only, with threaded hose connectors		
4612	Belt, nylon webbing		
F30	Constant flow control valve 1/4" Industrial Interchange (steel)		
F35	Constant flow control valve, 1/2" Industrial Interchange (steel)		
F40	Adjustable flow control valve, 1/4" Industrial Interchange (steel)		
Air Supply Hose Kits			
V10 Series Hoses (3/8" I.D.) for use with breathing air compressors			
4696	25-foot Starter hose with 1/4" Industrial Interchange Q.D. coupler		
46913	25-foot Starter hose with 1/4" Schrader Q.D. coupler		
46915	25-foot Starter hose with 1/4" Snap-Tite Q.D. coupler		
5454	25-foot Extension hose		
5457	50-foot Extension hose		
5458	100-foot Extension hose		
V20 Series Hoses (1/2" I.D.) for use with Free-Air Pumps			
V2050ST	50-foot Starter/Extension hose with 1/2" Industrial Interchange Q.D. coupler		
V20100ST	100-foot Starter/Extension hose with 1/2" Industrial Interchange Q.D. coupler		
V5 Series Coiled Hoses for use with breathing air compressors			
V52530	25-foot Starter hose with 1/4" Industrial Interchange Q.D. coupler		
V55030	50-foot Starter hose with 1/4" Industrial Interchange Q.D. coupler		
V52531	25-foot Starter hose with 1/4" Schrader Q.D. coupler		
V55031	50-foot Starter hose with 1/4" Schrader Q.D. coupler		
V52532	25-foot Starter hose with 1/4" Snap-Tite Q.D. coupler		
V55032	50-foot Starter hose with 1/4" Snap-Tite Q.D. coupler		

88VX Series Airline Respirator User Manual

CATALOG NUMBER DESCRIPTION

Quick-Disconnect Nipples

1/4" Industrial Interchange

S9841 With 1/4" Female NPT
V17 With 3/8" Female NPT

1/4" Schrader

S19432 With 1/4" Female NPT
S19433 With 3/8" Female NPT

1/4" Snap-Tite

S19442 With 1/4" Female NPT
S17651 With 3/8" Female NPT

Quick-Disconnect Couplers (Shut-off Type)

1/4" Industrial Interchange

V14 With 1/4" Female NPT
366254 With 3/8" Female NPT
366054 With 1/4" Male NPT
V15 With 3/8" Male NPT

1/4" Schrader

V18 With 1/4" Female NPT
S17603 With 1/4" Male NPT

CATALOG NUMBER DESCRIPTION

S17601 With 3/8" Male NPT

1/4" Snap-Tite

V19 With 1/4" Female NPT
S17615 With 3/8" Female NPT
S17611 With 1/4" Male NPT
S17614 With 3/8" Male NPT

Quick-Disconnect Hose Adapters

V11 Hose-to-hose, 3/8" hose to 3/8" hose
V12 Hose-to-pipe, 3/8" hose to 1/4" pipe
V13 Hose-to-pipe, 3/8" hose to 3/8" pipe

To order replacement parts, contact your local Bullard distributor or the Bullard Customer Service Department.

Bullard

1898 Safety Way
Cynthiana, KY 41031-9303
Toll Free: 877-BULLARD (285-5273)
Phone: 859-234-6616
Facsimile: 859-234-6858

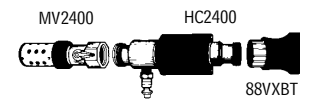
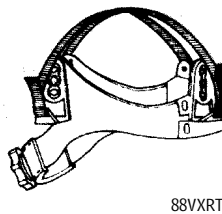
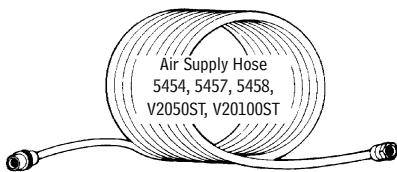
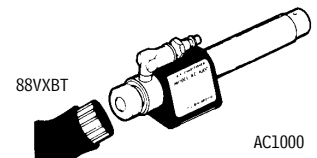
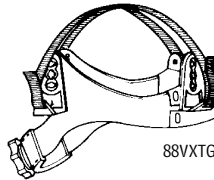
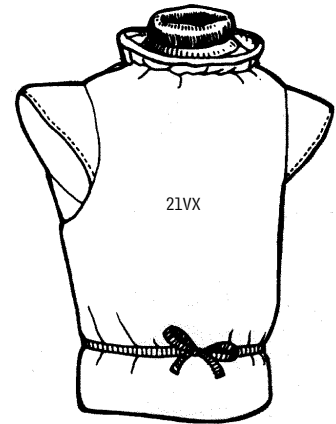
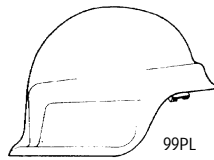
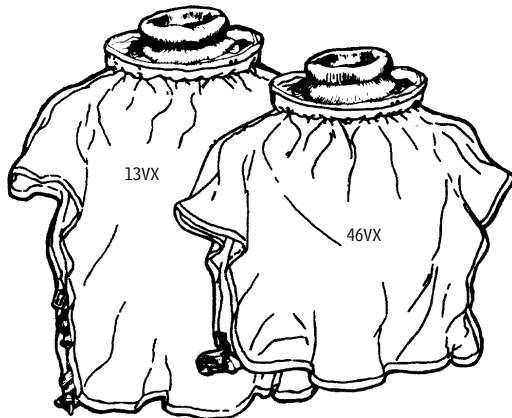

V5 Coiled Hose
V52530, V55030, V52531, V55031,
V52532, V55032

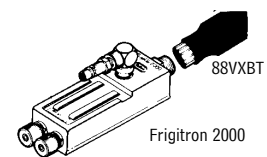
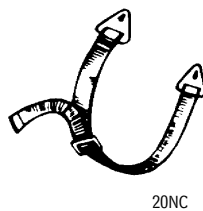

Other Available Flow Control Assemblies (Without Breathing Tube)

CATALOG NUMBER	DESCRIPTION
Adjustable Flow	
F40B	1/4" Industrial Interchange (brass)
F40S	1/4" Industrial Interchange (stainless steel)
F41	1/4" Schrader
F42	1/4" Snap-Tite (steel)
F43	1/4" Snap-Tite (brass)
F44	1/4" Snap-Tite (stainless steel)
F47	1/4" Cejn
F48	1/4" Bayonet

Constant Flow	
F30B	1/4" Industrial Interchange (brass)
F30S	1/4" Industrial Interchange (stainless steel)
F31	1/4" Schrader
F32	1/4" Snap-Tite (steel)
F33	1/4" Snap-Tite (brass)
F34	1/4" Snap-Tite (stainless steel)
F37	1/4" Cejn
F38	1/4" Bayonet
F35B	1/2" Industrial Interchange (brass)
F35S	1/2" Industrial Interchange (stainless steel)

Adjustable Climate Control Tubes

Cold Only	Hot/Cold	Dual-Cool	Coupling Type
AC100030B	HC240030B	DC5040B	1/4" Industrial Interchange (brass)
AC100030S	HC240030S	DC5040S	1/4" Industrial Interchange (stainless steel)
AC100031	HC240031	DC5041	1/4" Schrader
AC100032	HC240032	DC5042	1/4" Snap-Tite (steel)
AC100033	HC240033	DC5043	1/4" Snap-Tite (brass)
AC100034	HC240034	DC5044	1/4" Snap-Tite (stainless steel)
AC100037	HC240037	DC5047	1/4" Cejn
AC100038	HC240038	DC5048	1/4" Bayonet

88VX™ Series Airline Respirator User Manual

88VX Series Respirator Replacement Parts

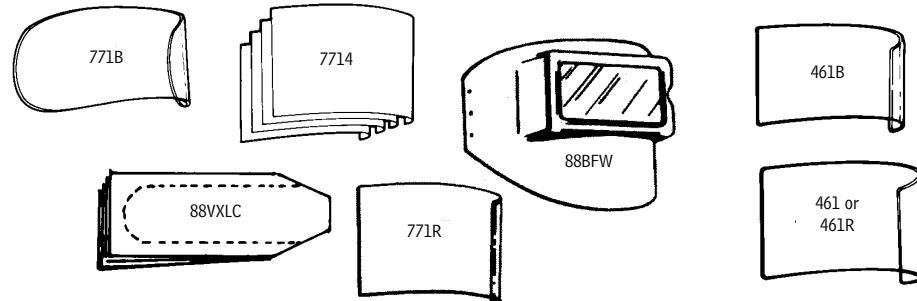
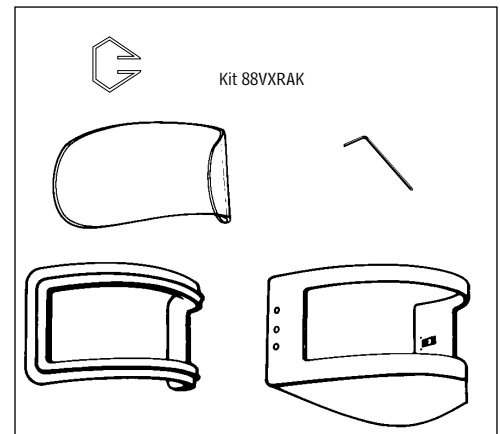
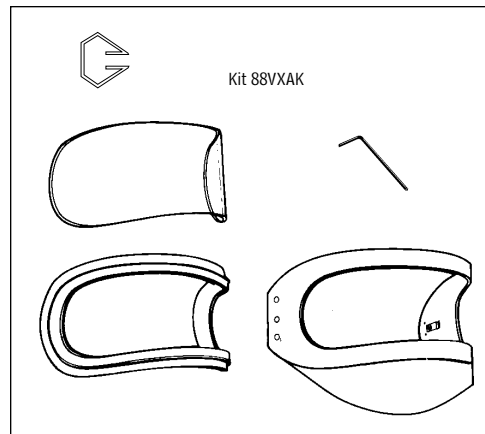
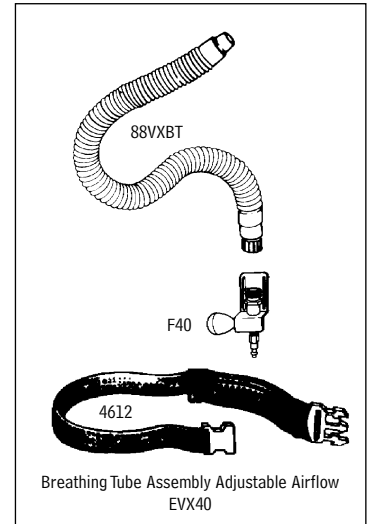
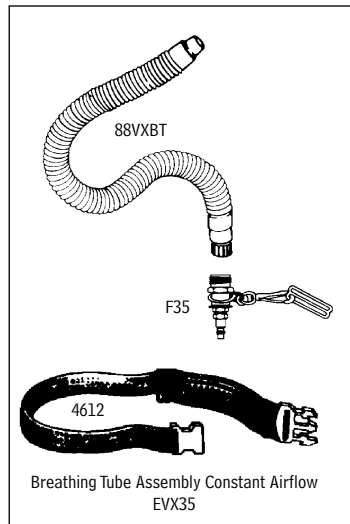
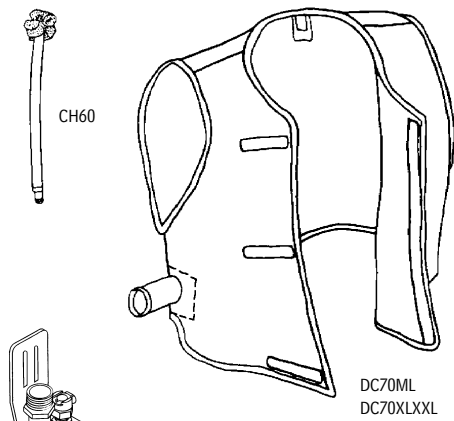



Head
Protection



Respiratory
Protection



Fire and Rescue
Safety



Thermal
Imaging

Return Authorization

The following steps must be completed before Bullard will accept any returned goods. Please read carefully.

Follow the steps outlined below to return goods to Bullard for repair or replacement under warranty or for paid repairs:

1. Contact Bullard Customer Support by telephone or in writing at:

Bullard
1898 Safety Way
Cynthiana, KY 41031-9303
Toll-Free: 877-BULLARD (285-5273)
Phone: 859-234-6611

In your correspondence or conversation with Customer Support, describe the problem as completely as possible. For your convenience, your coordinator will try to help you correct the problem over the phone.

2. Verify with your coordinator that the product should be returned to Bullard. Customer Support will provide you with written permission and a return authorization number as well as the labels you will need to return the product.
3. Before returning the product, decontaminate and clean it to remove any hazardous materials which may have settled on the product during use. Laws and/or regulations prohibit the shipment of hazardous or contaminated materials. Products suspected to be contaminated will be professionally discarded at the customer's expense.
4. Ship returned products, including those under warranty, with all transportation charges pre-paid. Bullard cannot accept returned goods on a freight collect basis.
5. Returned products will be inspected upon return to the Bullard facility. Bullard Customer Support will telephone you with a quote for required repair work which is not covered by warranty. If the cost of repairs exceeds stated quote by more than 20%, your coordinator will call you for authorization to complete repairs. After repairs are completed and the goods have been returned to you, Bullard will invoice you for actual work performed.

Bullard
1898 Safety Way
Cynthiana, KY 41031-9303
Toll free: 877-BULLARD (285-5273)
Tel: 859-234-6616
Fax: 859-234-8987
www.bullard.com

Bullard GmbH
Hochkreuzallee 36
53175 Bonn-Bad Godesberg
Germany
Tel: +49 228 931933 0
Fax: +49 228 931933 50



©2003 Bullard. All rights reserved.
Bullard, Free-Air, Sportek, Dual-Cool, and Sure-Lock are registered trademarks of Bullard.
"It's your life and you're worth it" and 88VX are trademarks of Bullard.